

## CTC EcoZenith i360

Indoor model with heat pump control

1. Sign the installation checklist.
2. Make sure to register your product for warranty and insurance purposes on our website: [www.ctc.se/registrera-din-installation-for-garanti](http://www.ctc.se/registrera-din-installation-for-garanti). (Serial no. behind magnetic strip above touchscreen).
3. Bleed radiator system and products approx. one month after installation, and at least once per year.
4. Screw in/close the bleed screw on the automatic bleeder approx. three months after installation.
5. Fit/turn the safety valve approx. four times per year.
6. Check the system pressure regularly and ask the installer what system pressure your system should have; this will normally be around 1 bar. If the pressure is too low, the system must be refilled.
7. Regularly clean the dirt filter (close off incoming tap water; remove and clean the filter)/solenoid filter ball valve (close off the flow to the heat pump; remove and clean the filter).
8. Set the correct heating curve for a comfortable room temperature; check that the thermostat valves on the element or floor heating are set up correctly. These may need to be opened.
9. Set the hot water mode according to your requirements.

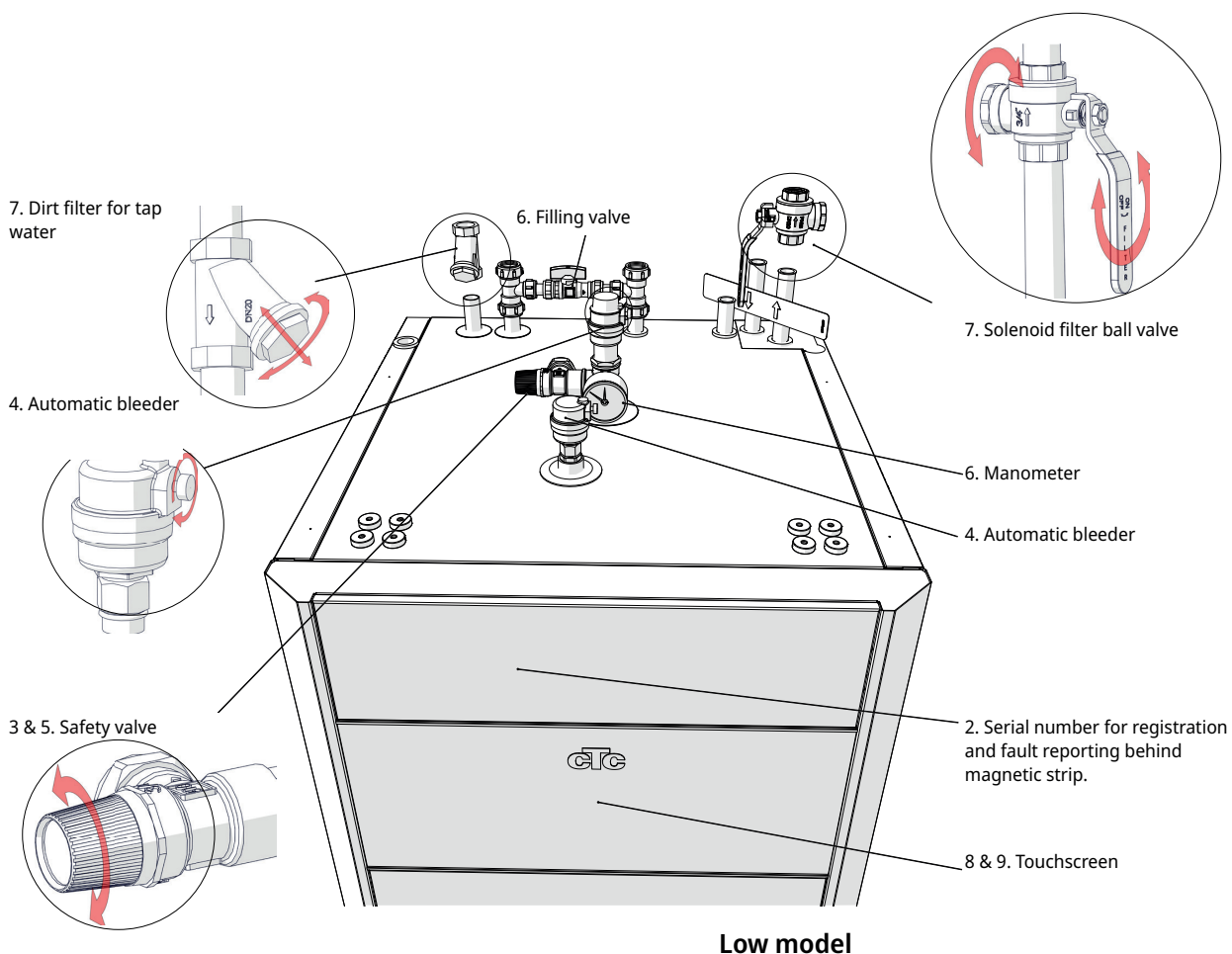

### Touchscreen

All product settings are set up via the touchscreen. Set the heat and hot water settings here.

### Internet & Communication

Built-in internet access via network cable. Adjust the product directly from your home via a tablet, mobile phone or computer, or remotely via the app. See chapter "Installation Communication" in the Installation and Maintenance Manual for the product.

### Outdoor sensor

Measures outdoor temperature; placement should not be in direct sunlight or where the measured outdoor temperature may be misleading. The outdoor sensor provides the product with information on the current need for heat.

### Room sensor

Measures indoor temperature and finely adjusts the heating curve so that the product runs more evenly. The room sensor is optional and the product can work using only the heating curve. The room sensor should preferably not be activated until the heating curve has been completely adjusted. The room sensor is fitted at a central point in the house, in the most open position possible. This is the best position for the sensor to record an average temperature for the house.

### Clean, safe hot water

The water in the tank (as in the heat pump and radiators) rises and is layered so that the hottest water surrounds the DHW heat exchanger where the tap water flows through quickly, draws energy and flows out to the tap or shower. This provides fresh hot water and minimises the risk of legionella bacteria.

### Heat pump

The heat pump is connected to the product and provides energy obtained from the air or bedrock. See the heat pump manual for information on servicing and checking the heat pump. Remember that the brine fluid must be checked and refilled as needed.

### Electrical operation

The product can also provide both heating and hot water to the building when running on electricity only. With the heat pump connected, the electric heater works to provide additional heat as needed only. The touchscreen can be used to set whether the electric heater goes in and with how much power.

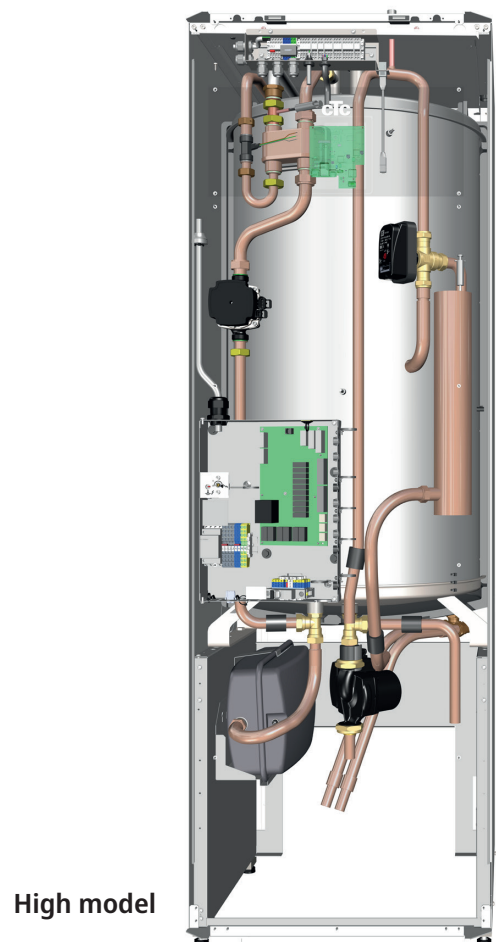
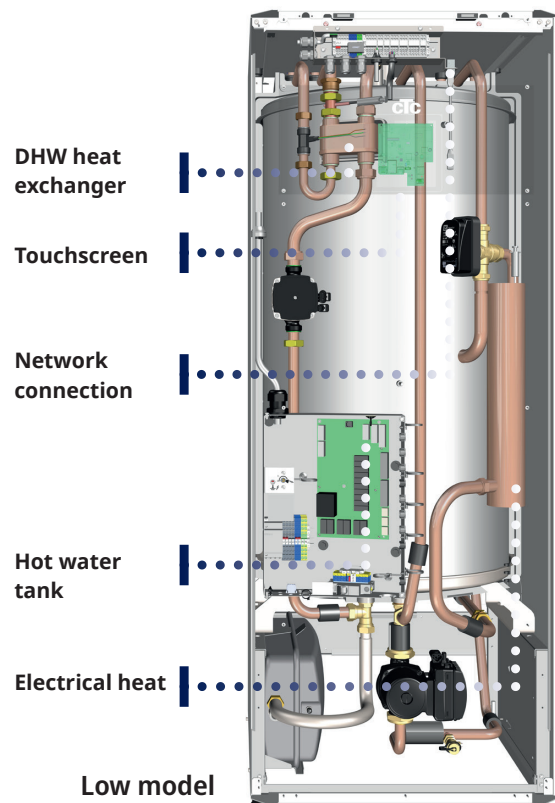

## Options with CTC EcoZenith i360

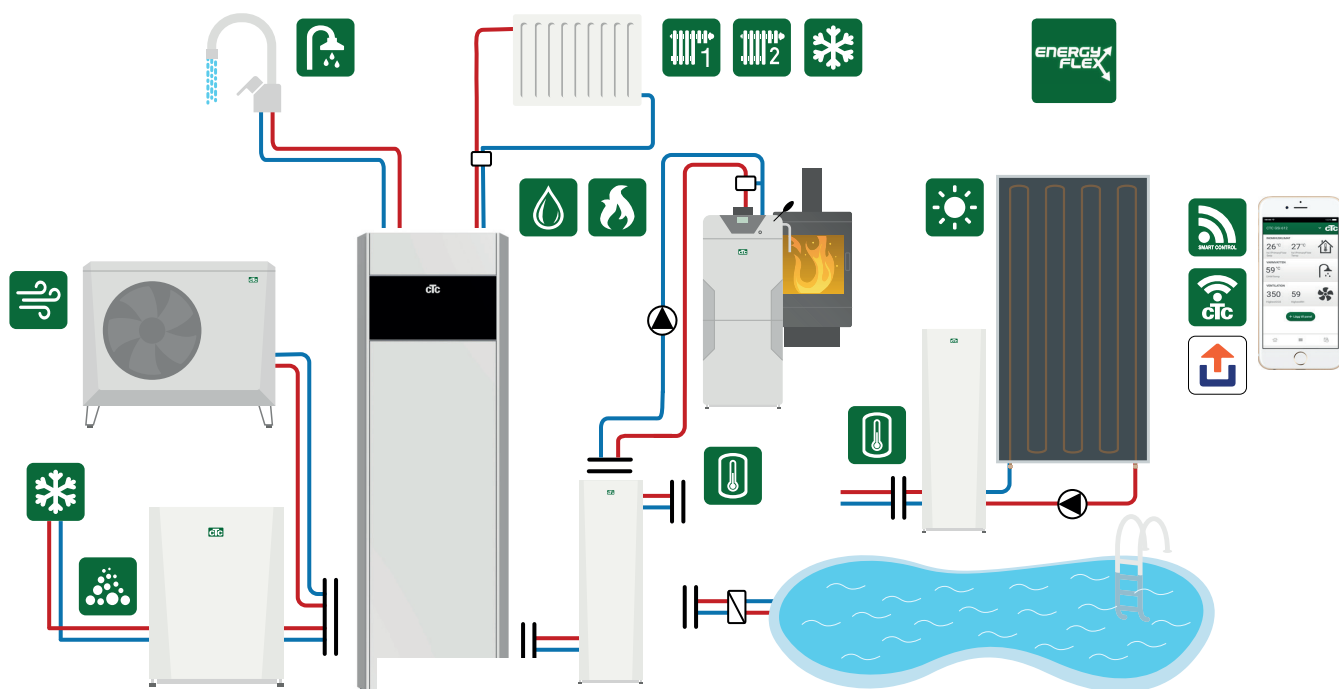

\* In addition to the basic installation, accessories are required such as: Extra sensor, Mixing Valve group 2, Expansion Card, etc. Volume tank CTC VT 80 may be required for some houses (see installation manual for more information).







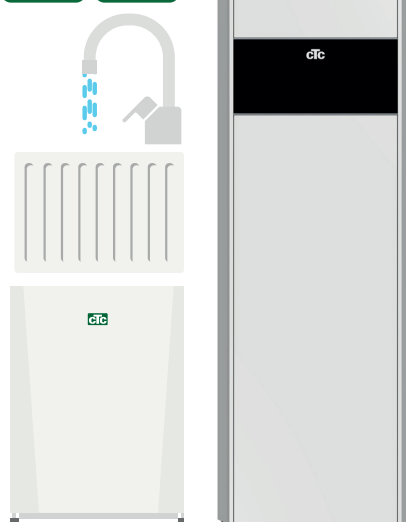
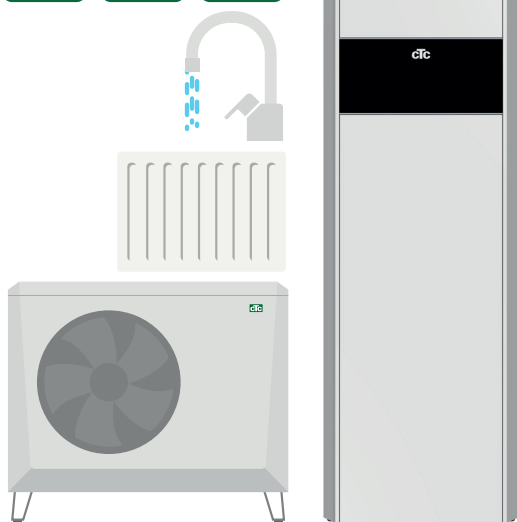

## Basic installation, CTC EcoZenith i360

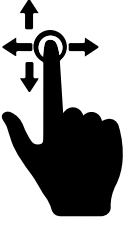
EcoZenith i360  
 1 heating circuit  
 1 compatible heat pump  
 in the EcoAir 400, 500M or 600M series

EcoZenith i360  
 1 heating circuit  
 1 compatible heat pump  
 in the EcoPart 400 or 600M series



# Navigate on the touchscreen

	Scroll & Swipe	 Start menu	 Increase value	
	Single click = Select	 Back	 Next	 Select and save
	Double click = Open	 Decrease value	 Increase value	 Decrease value

## Start menu

### Room temperature Heating Circuit 1

Measured by Room Sensor 1.

### Room temperature Heating Circuit 2

Measured by Room Sensor 2.

### Tank temperature

Measured by DHW Sensor in upper tank.

### Outdoor temperature

Measured by Outdoor Sensor.

### Installer

Settings and service.

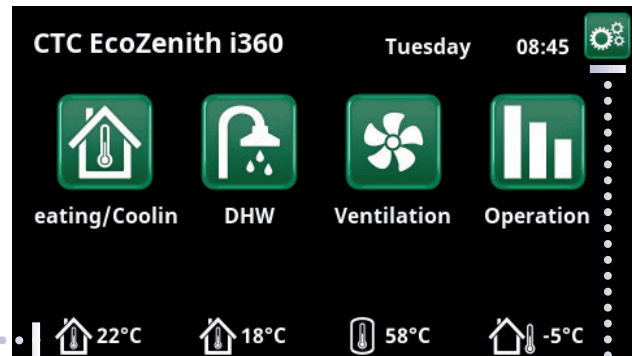

## Heating / Cooling

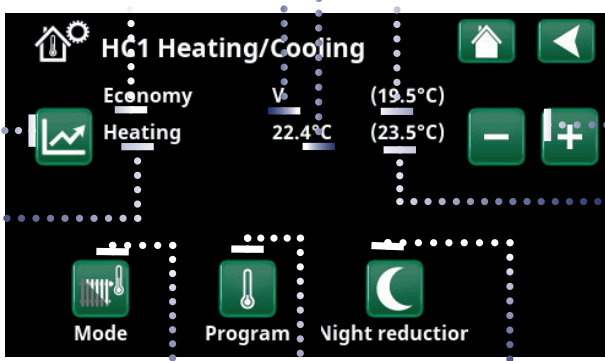

Mode economy active.

Heat curve - Adjust primary flow temperature to the heating circuit at different outdoor temperatures.

Heating circuit 1 in heating mode.

Holiday mode (H) active.

Measured temperature, room sensor.

Actual setpoint after holiday and economy reduction.

Mode, heating - Set the "Heating mode": "Auto", "On" or "Off".

Program, heating - Set temperature increases/decreases for the heating programmes (Economy, Comfort, Custom).

Night reduction - Set a higher or lower temperature for a certain time of day. If active, NR is displayed.

Fine adjustment temperature.

Set setpoint.



## DHW

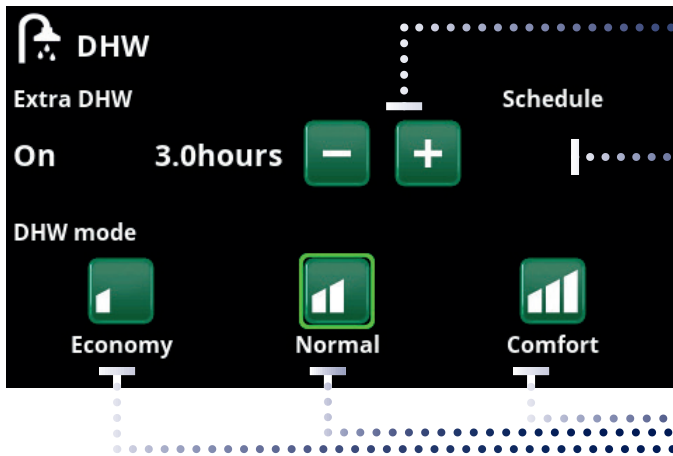

### Start Extra DHW Timer

#### Weekly program "Extra DHW"

Tip: Set the time approx. 1 hour earlier than when you need the hot water as it may take some time to heat.

### Select DHW program.

Comfort – Large DHW requirement.

Normal – Normal DHW requirement.

Economy – Small DHW requirement.

Allow additional heat and electric heater for reliable comfort at all times. To ensure hot water comfort in all operating conditions, it may be necessary to allow additional heat. If there is no heat pump or other heat source installed, these settings need to be changed so that the product can function as an electric boiler. "Installer / Settings / DHW Tank / Add Heat DHW - Yes".



## Ventilation

Refer to the accessory manual. The symbol is only displayed on the home screen if EcoVent is defined.



## Operating information

Press the images to see detailed information on each part.

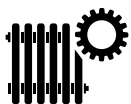

Shortcut to Settings, Heating Circuit.

Heating Circuit

Control and tank

Heat pump

Functions

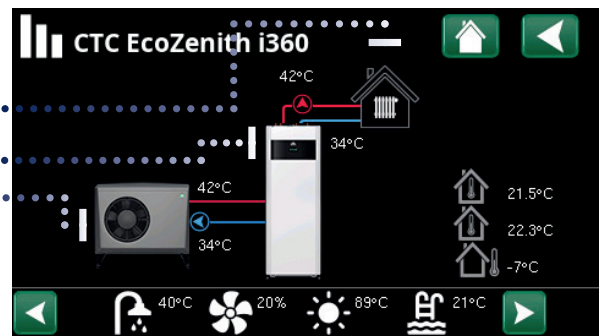

## Alarm management

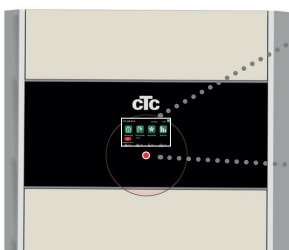

Refer to the troubleshooting table at the end of the installation manual.



Call your installation engineer in the first instance.

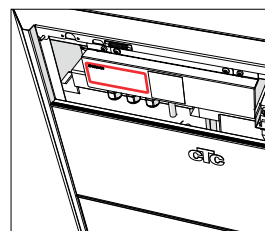
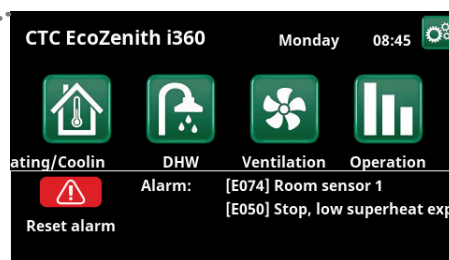

The serial number (12 digits) can be found behind the magnetic strip. This number is needed to be given to the installation engineer and CTC support in the event of a fault report.

- **Green LED** - Status OK.
- **Red/yellow flashing LED** Alarm.
- **Green flashing diode** - Operation with active electric heater (only applies to language selection "Danish").
- **Info message** at bottom.



# Heat settings

The product regulates itself to provide a constant, comfortable temperature throughout the year using the set heating curve. The curve may need to be changed using the touchscreen if the room temperature feels too cold or hot over time. For information on how to do this, see "Navigate touchscreen" on the previous page. Correction may be required for a few weeks after installation until the system has been matched to the building. For more information, see the Installation and Maintenance Manual, section: The house heating curve.

## Find the right heating curve

- The heating curve for the house is determined by two main factors: inclination and adjustment. These can be changed to fit the house's energy needs for heating.
- The house's heating needs depend on:
  - The size of the house (volume/area)
  - Insulation
  - Window area
  - > inclination and adjustment increase the more energy is required.
- Thermal conductivity of the radiators
  - Elements
  - Floor heating
  - Number of elements/surfaces for heat transfer
  - > inclination and adjustment decrease the faster energy is discharged.

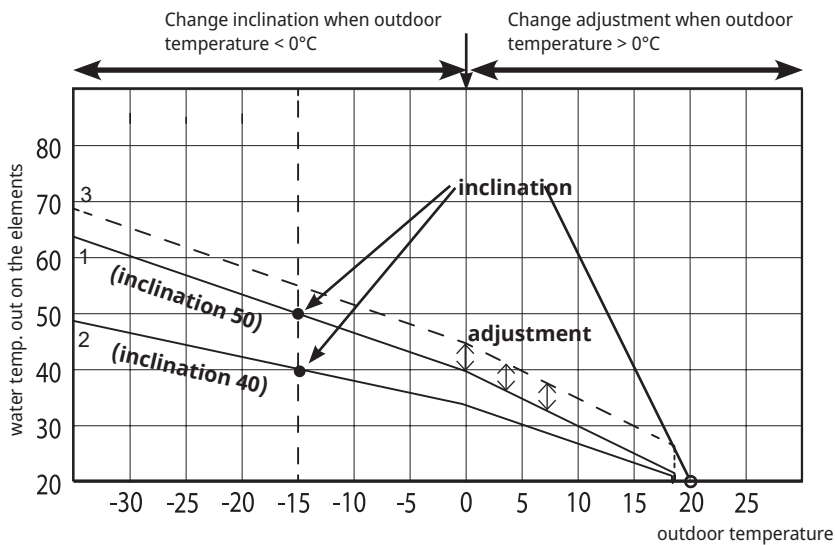

## Examples of inclination values for different systems

Floor heating only.	inclination = 35
Low temperature system (well-insulated houses).	inclination = 40
Normal temperature system (factory setting).	inclination = 50
High temperature system (older houses, small radiators, poorly insulated).	inclination = 60

## Example in image:

1. Inclination 50, Adjustment 0°
2. Inclination 40, Adjustment 0°
3. Inclination 50, Adjustment 5°

# Energy consumption

The total energy consumption of the product is linked to:

- The energy needed by the house, which varies significantly through the year depending on the outdoor temperature (see image on energy consumption, right).
- DHW consumption.

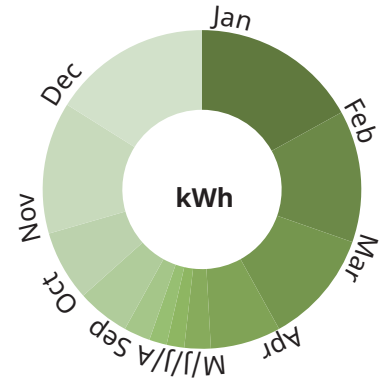

- Remember:**
- Energy consumption is much higher in the winter months than in the summer months
  - Energy consumption increases when DHW consumption is high
  - What is important is the total energy bill for the year.

## Energy-saving tips

- Make sure that the thermostat valves on the house's element are open in most rooms; only adjust downwards in bedrooms, for example.
- Use the DHW chart for extra DHW to avoid high-temperature operation when it is not needed.
- Install a room sensor; this provides more even heat and compensates for natural solar radiation or other natural heat sources.
- Clean any dirt filters regularly; a deterioration in water flow can increase the electricity used by the circulation pump.
- Make sure the speed of the charge/circulation pump provides the right flow (see the chapter "System adjustments" in the Installation and Maintenance Manual).

## Schedule and remote control

- Extra DHW schedule
- Ventilation
- Night reduction
- Heating, mode
- SmartGrid
- Modbus TCP
- Block Passive cooling
- Blocking Pool
- Tariff EL
- Tariff ext. boiler
- Heat pump tariff
- Round circulation
- DHW circulation
- Flow/level switch
- Noise reduction & silent mode, heat pump

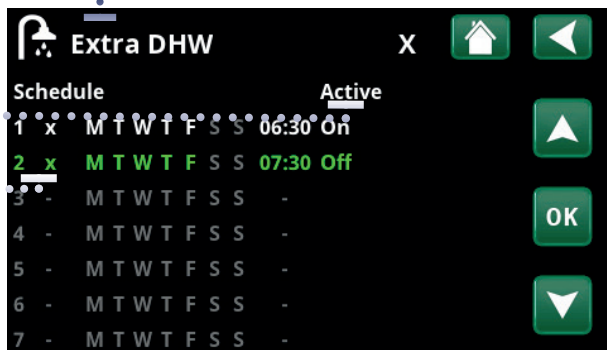
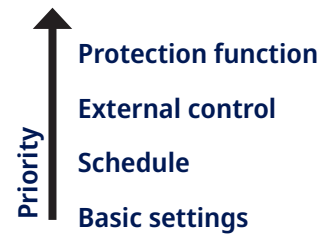

- Only the "x" row will transmit a signal.
- Only the active schedule affects operation.

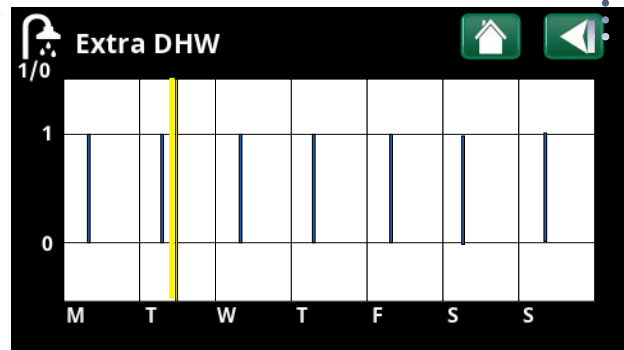

- Scroll between setting and preview.
- The blue bars are displayed when "Extra DHW" is active.
- The yellow bar indicates the current time. The X axis represents the days, Monday to Sunday.

# Checklist

## The checklist must always be completed by the installation engineer

- If a service is performed, you may be required to provide this document.
- Installation must always be carried out according to the installation and maintenance instructions.
- Installation must always be carried out in accordance with best professional practice.
- Following installation, the unit must be inspected and checked for functionality.

## The points below must be checked off.

### Pipe installation

- Product filled, positioned and adjusted in the correct manner according to the instructions.
- Product positioned so that it can be serviced.
- Capacity of charge pump (G11) adjusted for correct flow.
- Open radiator valves and other relevant valves.
- Tightness test.
- Bleed the system.
- Safety valve function test.
- Waste pipe connected to floor drain.

### Electrical installation

- Omnipolar switch.
- If the heat pump is installed: heat pump activated and started.
- Electrical power (kW) and fuse, adapted for the property, in heat mode, in hot water mode, in reserve mode and according to national regulations for new constructions.
- Correct tight wiring.
- Requisite sensors for selected system.
- Outdoor sensor.
- Room sensor (optional).
- Current sensor.
- Accessories.

### Customer information (adapted to the relevant installation)

- Start-up with customer/installer.
- Menus/controls for selected system.
- Installation and maintenance manual supplied to the customer.
- Check and filling, heating circuit.
- Trimming information, heat curve.
- Alarm information.
- Safety valve function test.
- Register your Installation Certificate at [ctc.se](http://ctc.se). ([ctc-heating.com](http://ctc-heating.com)).
- Information on procedures for fault registration.

## The above points have been reviewed upon installation

---

Date/Place

---

Signature/HVAC installation engineer

Tel. no.

---

Customer's signature

---

Signature/Electrician Tel. no.

---

Product

---

Serial number